

(A) Case for Labeling: Labeling in Languages without ϕ -feature Agreement*

Mamoru Saito

1. Introduction

Among the fundamental questions in minimalist research is why human language has ϕ -feature agreement and Case. Chomsky (2013) proposes a partial answer for this with his labeling algorithm. The operation Merge, which combines two elements α and β into $\{\alpha, \beta\}$, is minimally required for language. This operation, he argues, must accompany an algorithm that specifies the nature of the formed object. For example, when a verbal element and a nominal element form a constituent, information must be provided whether the constituent is verbal (VP) or nominal (NP). His proposal is that ϕ -feature agreement plays a crucial role in this labeling process. On the other hand, it is proposed in Chomsky (2008), for example, that Case is necessary for ϕ -feature agreement and is valued through it. This leads to the picture in (1), where ‘ \rightarrow ’ means ‘requires’.

(1) Merge \rightarrow Labeling \rightarrow ϕ -feature agreement \rightarrow Case

These hypotheses successfully place ϕ -feature agreement and Case in the model of syntax in a way that is consistent with the strong minimalist thesis. At the same time, they present interesting research questions when languages like Japanese that are rich in Case but apparently lack ϕ -feature agreement are taken into consideration. If Japanese, for example, indeed lacks ϕ -feature agreement, how is labeling accomplished in the language? How is Case valued in the language and why does the language have Case to begin with? One possibility is that the language after all has abstract ϕ -feature agreement, and this is tacitly assumed widely in the current literature. Among the relevant works are Ura (1999), Hiraiwa (2001) and M.

* This is an extended version of Saito (2014a). The new material was presented in seminars at Keio University, the University of Southern California and the University of Connecticut, and also at *Cambridge Comparative Syntax 4: Rethinking Comparative Syntax*, held on May 7-9, 2015. I have benefitted from discussions with many people, especially Željko Bošković, Hisa Kitahara, Audrey Li, Luigi Rizzi and Daiko Takahashi. I would also like to thank two anonymous reviewers for comments that led to improvement at various places. The research reported here was supported in part by a JSPS Grant-in-Aid for Scientific Research (C) (#25370445, 2013-2015) and a Nanzan University Pache Research Subsidy I-A-2 (2015). This paper is dedicated to the memory of Yoshiyuki Shibata.

Takahashi (2010). However, there is also a long tradition trying to attribute the syntactic properties of Japanese, such as those in (2) discussed in Hale (1980) and Kuroda (1988), to the absence of ϕ -feature agreement at least in the form assumed for standard ϕ -feature agreement languages.

- (2) a. free word order
 b. wide distribution of null arguments
 c. extensive employment of complex verb-words
 d. multiple occurrences of Case markers

The concrete proposals vary in form. Kuroda (1988) argues that there is agreement in Japanese but it is optional and need not be 1-1 whereas Fukui (1988) proposes that the language lacks functional categories altogether.¹ More recently, Miyagawa (2010) presents a hypothesis that Topic/Focus features play the role of ϕ -features in discourse configurational languages like Japanese.

The purpose of this paper is to explore the labeling mechanism and the role of Case in Japanese on the premise that it lacks ϕ -feature agreement altogether. The entertained hypothesis is that suffixal Case in the language serves to make a constituent invisible for labeling and hence, plays a crucial role in the labeling algorithm. In the first part of the paper, I present this hypothesis and argue that it leads to explanations for multiple occurrences of Case markers, free word order, and with its extension to predicate inflection, extensive employment of complex verbs with specific syntactic properties. In the latter part, I examine ellipsis, in particular argument ellipsis, and show that the hypothesis accounts for its distribution to a large extent. At the end, I briefly consider other languages with argument ellipsis and raise the possibility that Case, regardless of whether it is suffixal or not, contributes to labeling. This, if correct, implies that Case, rather than ϕ -feature agreement, plays a fundamental role in labeling. I speculate that the role of ϕ -feature agreement, when present, is to make Case valuation possible.

In the following section, I discuss the role and valuation of Case in Japanese. I adopt Bošković's (2007) proposal that Case valuation takes place independently of ϕ -feature agreement and show that it immediately accounts for examples with multiple occurrences of Case markers such as (3).

¹ More precisely, Kuroda (1988) is not concerned with ϕ -feature agreement per se but discusses Case assignment and Wh-C Spec-head agreement as instances of agreement. See also Saito (1982) and Yang (1983) for earlier and more limited attempts to explain the parametric properties of Japanese and Korean in terms of the absence of ϕ -feature agreement.

- (3) Bunmeikoku-ga dansei-ga heikin-zyumyoo-ga mizika-i (Kuno 1973)
 civilized.country-NOM male-NOM average-life.span-NOM short-Pres.
 ‘It is in civilized countries that male’s average life span is short.’

Then, I propose that Case marker in Japanese serves as an anti-labeling device that makes a constituent invisible for labeling. This means that in (4), for example, only β is visible and hence provides the label of γ .

- (4) $\gamma = \{\alpha\text{-Case}, \beta\}$

I show that this hypothesis leads to an explanation for why DP scrambling is possible in Japanese. Then, building on the insights of Sells (1995) and An (2009), I propose that inflection on predicates serves as an anti-labeling device exactly like Case markers. This makes it possible to account for scrambling of adverbs, which accompany preverbal inflection.

Section 3 concerns a prediction of the hypothesis on inflection just mentioned. The prediction is that complex verbs can be formed by Merge as in (5) in Japanese.

- (5) $\{V\text{-inflection}, V\}$

I argue that this prediction is indeed borne out by what Kageyama (1993) calls lexical complex verbs.

I turn to ellipsis in Section 4. Oku (1998) and Kim (1999) have shown that arguments can be elided in Japanese and Korean. A typical example is shown in (6b).

- (6) a. Taroo-wa itumo zibun-no hakaseronbun-o inyoosu-ru
 T.-TOP always self-GEN dissertation-ACC cite-Pres.
 ‘Taroo always cites his Ph.D. dissertation.’
- b. Demo, Ziroo-wa zenzen [*e*] inyoosi-na-i
 but Z.-TOP at.all cite-not-Pres.
 ‘But Ziroo does not cite (his Ph.D. dissertation) at all.’
- c. Demo, Ziroo-wa zenzen sore-o inyoosi-na-i
 but Z.-TOP at.all it-ACC cite-not-Pres.
 ‘But Ziroo doesn’t cite it at all.’

The null object in (6b) allows sloppy interpretation and can be construed as Ziroo's dissertation. This shows that it cannot be analyzed simply as a null pronoun because a pronoun only permits strict interpretation as shown in (6c). Given examples of this kind, Oku and Kim conclude that arguments such as the subject and the object can be elided.

This raises a question why argument ellipsis is possible in Japanese and Korean, as opposed to languages like English. Adopting Richards' (2003) proposal that an elided constituent counts as a head in syntactic computation, I argue that it is Case marker as an anti-labeling device that makes argument ellipsis possible. Then, I extend the analysis to Malayalam and Turkish, which allow object ellipsis but not subject ellipsis.

In Section 5, I briefly discuss Chinese, another language with the same subject-object asymmetry in argument ellipsis, and speculate that Case valuation, as opposed to ϕ -feature valuation, creates a configuration of feature sharing that makes labeling possible. This, if correct, implies that Case universally plays a more important role in labeling than has been assumed. Based on this, I reconsider the roles of ϕ -feature agreement and Case, and suggest that ϕ -feature agreement, when present, is a condition on Case valuation.

2. The Function and Valuation of Case in Japanese

I first discuss the mechanism of Case valuation in Japanese and then consider the role of Case in the language. The proposed analysis predicts correctly that the language allows multiple occurrences of Case markers and DP scrambling.

2.1. Bošković's (2007) Proposal that Case Probes for its Value Provider

As noted at the outset of this paper, Chomsky (2008), for example, proposes that Case is valued through ϕ -feature agreement. (7) illustrates this with nominative Case.

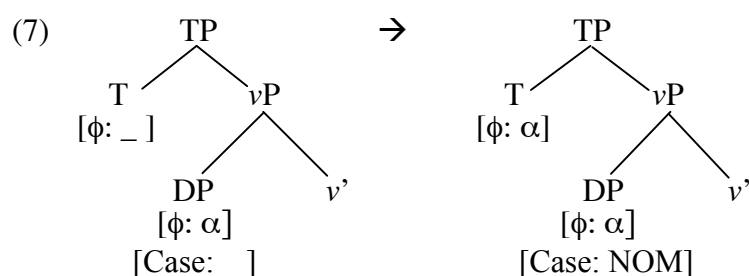

T with unvalued ϕ -features probes for a DP with ϕ -feature values, and enters into Agree

relation with the DP.² T obtains the ϕ -feature values α from the DP through this Agree relation. And as a reflex of this, the Case feature of the DP is valued nominative. Chomsky, in addition, proposes the activation condition in (8).

- (8) Activation condition: α can participate in Agree only if it has an uninterpretable (unvalued) feature.

Given this, the Case feature of the DP makes the Agree relation in (7) possible. Then, Case is required for ϕ -feature agreement.

Chomsky's analysis cannot be straightforwardly assumed for Case valuation in Japanese if the language lacks ϕ -feature agreement. There is in fact some evidence that Case valuation in Japanese is independent of ϕ -feature agreement. First, the language is abundant with clear cases of PP subjects, as shown in (9).

- (9) a. Koko-kara-ga huzi-san-ni nobori-yasu-i
 here-from-NOM Mt. Fuji-DAT climb-easy-Pres.
 'It is from here that one can easily climb Mt. Fuji.'
- b. Go-zi-made-ga untin-ga yasu-i
 5-o'clock-to-NOM fare-NOM cheap-Pres.
 'It is up to 5 o'clock that the fare is cheap.'

Further, PPs are required to be in genitive within nominal projections. The examples in (10) are ungrammatical without the genitive *no* on both the subject and the PP.

- (10) a. Taroo-no Yooroppa-e-no ryokoo
 T.-GEN Europe-to-GEN trip
 'Taroo's trip to Europe'
- b. Hanako-no Tookyoo-kara-no syuppatu
 H.-GEN Tokyo-from-GEN departure
 'Hanako's departure from Tokyo'

As PPs do not have inherent ϕ -features, it is difficult to maintain that the nominative in (9)

² Chomsky (2008) hypothesizes that unvalued ϕ -features originate in phase heads, C and v , and are inherited by T and V. Following this, I assume that T and V have those unvalued features and value Case features as nominative and accusative respectively.

and the genitive in (10) on the PPs are valued through ϕ -feature agreement.

Then, how is Case valued in Japanese? There is a proposal in the literature to dissociate Case valuation from ϕ -feature agreement, and I show in the remainder of this subsection that it can be successfully applied to Japanese. Bošković (2007) presents a hypothesis that feature valuation uniformly occurs in the probe. His alternative to Chomsky's (7) is illustrated in (11).

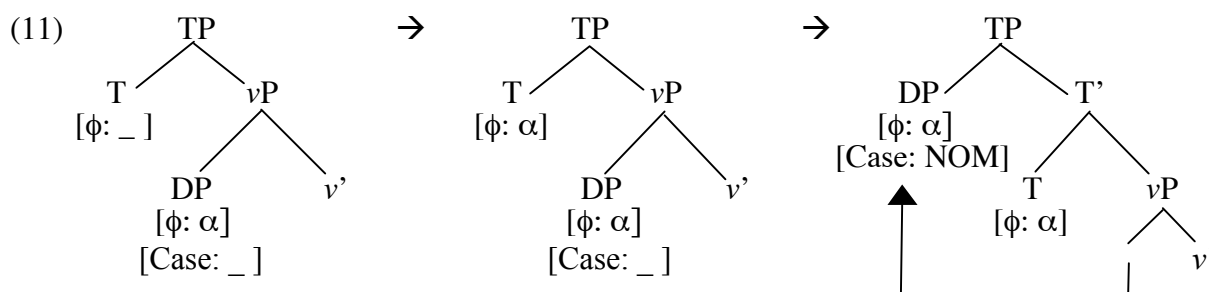

T with unvalued ϕ -features probes for the subject DP and the ϕ -features are valued as α exactly as in (7). But the Case feature of the DP is not valued at this point. The DP moves to Spec, TP to probe for the Case value provider T and have its Case valued as nominative. This analysis dispenses with the activation condition. When the subject DP probes for T and enters into Agree relation with it, T no longer has an unvalued feature.

As Case valuation does not depend on ϕ -feature agreement, this analysis can be applied directly to Japanese. Further, it has an immediate desirable consequence. As noted above, Japanese allows multiple occurrences of Case markers. The example of multiple nominative subjects in (3) is repeated below in (12).

- (12) Bunmeikoku-ga dansei-ga heikin-zyumyoo-ga mizika-i
 civilized.country-NOM male-NOM average-life.span-NOM short-Pres.
 'It is in civilized countries that male's average life span is short.'

Bošković's analysis predicts examples of this kind to be possible. The nominative Cases in (12) can be accounted for as in (13).³

³ Bošković (2012) proposes a parameter that distinguishes between DP languages with definite articles and NP languages without. The hypothesis has been explored extensively, and Takahashi (2011), for example, presents an analysis of Japanese as an NP language. I assume in this paper that nominal arguments in Japanese are DPs but not crucially. The arguments and the proposals can be restated on the assumption that they are NPs or KPs.

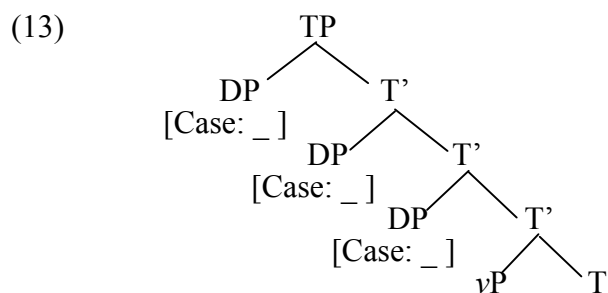

As all the subjects can probe for T, their Cases can all be valued as nominative.

It is argued in Kuroda (1988) that Japanese allows multiple accusative objects as well. It is known since Harada (1973) that simple sentences with two accusative phrases are marginal in the language. (14a) is an example.

(14) a. ??Taroo-wa kudamono-o ringo-o hitotu-dake tabe-ta
 T.-TOP fruit-ACC apple-ACC one-only eat-Past
 ‘Taroo ate fruits but he ate only one apple.’

b. [_{CP} Taroo-ga kudamono-o tabe-ta no]-wa ringo-o hitotu-dake da
 T.-NOM fruit-ACC eat-Past COMP-TOP apple-ACC one-only Cop.
 ‘*Lit.* It is only one apple that Taroo ate fruits.’

However, as Harada points out, those examples become perfect when one of the accusative phrases is dislocated.⁴ (14b) is grammatical as one of the objects is placed in the focus position of a cleft sentence. Given this, Kuroda concludes that multiple accusative objects are allowed in the language, at least in principle.⁵ Bošković’s (2007) Case valuation mechanism

⁴ When the causee and the embedded object are both in accusative in a causative sentence, the sentence is totally ungrammatical and the dislocation of one of these phrases does not lead to improvement. I assume that this case is to be analyzed independently. See Harada (1973) and Kuroda (1978) for the differences between this case and examples like (14a).

⁵ Based on this, Kuroda argues that the relation of Case assigner and assignee can be one-to-many in Japanese, a proposal that can be considered a precursor of Hiraiwa’s (2001) multiple agree.

It is worth pointing out that the two accusative objects in (14a) both receive the theme role from the verb. In addition, the second is construed as a focus and the first as an indefinite indicates the domain of alternatives in the sense of Rooth (1992). This kind of multiple theta-role assignment can be observed with other thematic roles as well, as shown in (i).

readily accounts for this as well. Two objects can probe V and have their Cases valued as accusative, as shown in (15).

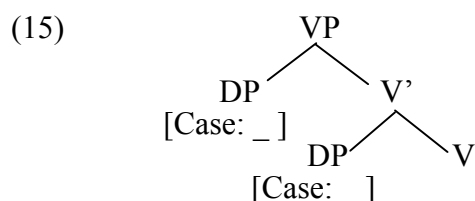

Interestingly, what needs to be accounted for under Bošković's theory is why languages like English do not allow multiple nominative subjects or multiple accusative objects, that is, in Kuroda's (1988) terms, why Case assigner and assignee are in 1-1 relation in these languages. I return to this problem in the following subsection and again in Section 5.

2.2. Suffixal Case for Labeling

As noted in the preceding subsection, Chomsky's (2008) activation condition in (8) makes Case necessary for ϕ -feature agreement. However, given Bošković's (2007) proposal to dissociate Case and ϕ -feature valuations and to eliminate the activation condition, it becomes necessary to reconsider the role of Case in syntactic computation. In this subsection, I focus on Japanese Case markers and suggest that they accommodate labeling. But before I present this hypothesis, I briefly go over Chomsky's (2013) proposals on labeling.

Merge applies to two objects α and β , and forms a new object $\gamma = \{\alpha, \beta\}$. Chomsky (2013) hypothesizes that it must accompany an algorithm to determine the nature (or label) of the newly formed object. He considers the three cases listed in (16).

-
- (i) a. ??Nihon-kara Hiroshima-kara-dake sankasya-ga at-ta
 Japan-from Hiroshima-from-only participant-NOM be-Past
 'There were participants from Japan, but only from Hiroshima.'
- b. [_{CP} Nihon-kara sankasya-ga at-ta no]-wa Hiroshima-kara-dake da
 Japan-from partipants-NOM be-Past COMP-Top Hiroshima-from-only Cop.
 'Lit. It is only from Hiroshima that there were participants from Japan.'

In these examples, both *Nihon* and *Hiroshima* assume the source role. Examples of this kind raise doubts on the theta-criterion, which stipulates that each thematic role is assigned to exactly one argument, and suggest that its effects, when correct, must be explained on independent grounds. I suggest below that labeling plays a crucial role here.

- (16) a. $\gamma = \{H, \alpha P\}$
 b. $\gamma = \{\alpha P, \beta P\}$
 c. $\gamma = \{H_1, H_2\}$

(16a) is straightforward as search into γ immediately yields a unique head, H. In this case, it can be assumed that H determines the label of γ . On the other hand, (16b-c) are problematic because the label of γ cannot be determined straightforwardly. Given this, Chomsky makes two concrete proposals to accommodate instances of (16b) that arise in actual derivations. Let us consider the structure in (17).

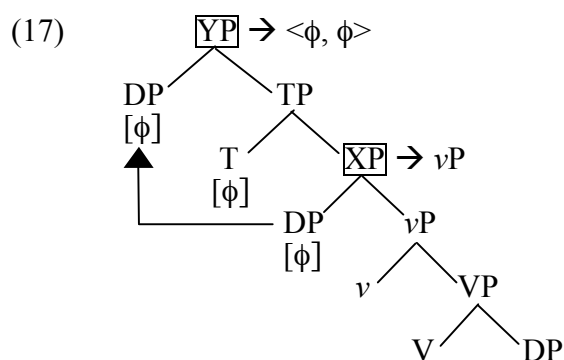

Merge applies first to yield $\{V, DP\}$ and then $\{\nu, \{V, DP\}\}$. These cases are instances of the unproblematic (16a). But then, the configuration in (16b) arises when the subject DP and νP merge. In this case, the DP internally merges with TP later in the derivation after T is introduced into the structure. Chomsky proposes that νP determines the label of XP at this point because it is the unique element that XP properly contains. The internal merge of DP with TP again creates an instance of (16b). Here, the DP and (the label of) TP share the same ϕ -features due to ϕ -feature agreement. Chomsky proposes that this feature sharing makes it possible to label YP as $\langle \phi, \phi \rangle$.

Chomsky (2013) points out that this analysis extends to structures created by wh-movement. Let us consider the following examples:⁶

- (18) a. [_{YP} What [_{CP} do [_{TP} you think [_{XP} [_{CP} that [_{TP} John bought]]]]]]]
-
- b. [_{YP} Who [_{CP} did [_{TP} you tell] [_{XP} what [_{CP} that [_{TP} John bought]]]]]]]
-

⁶ The movements proceed through the edges of νP as well. I ignore this for ease of exposition.

There are two instances of internal merge of a wh-phrase with a CP in (18b). The one in the matrix is legitimate as the C heads a question with the feature Q, and the formed object (YP) can be labeled as $\langle Q, Q \rangle$ with feature sharing. The one in the embedded clause, on the other hand, results in failure of labeling of XP. Since the C head lacks Q, there is no feature sharing. Merger of a wh-phrase with a non-question CP is allowed in the embedded clause of (18a). This is so because the wh-phrase moves further, and as a result, CP provides the label of XP as the only element properly contained within XP. The matrix YP is labeled as $\langle Q, Q \rangle$ with feature sharing.

(17) illustrates Chomsky's (2013) proposal that ϕ -feature agreement plays a crucial role in the labeling of a sentence. This immediately raises a question on how sentences are labeled in languages without ϕ -feature agreement. For Japanese, there are other structures to be considered as well. The structure of the noun phrase in (19) is an example.

- (19) a. Taroo-no yooroppa-e-no hon-no yuusoo
 T.-GEN Europe-to-GEN book-GEN shipment
 'Taroo's shipment of books to Europe'

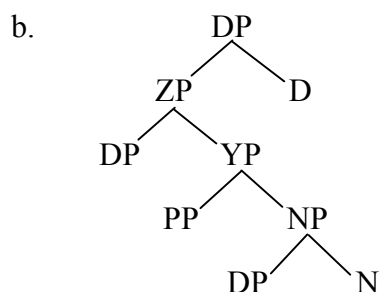

Details aside, the merger of the goal PP with NP is potentially problematic because it is an instance of $\{\alpha P, \beta P\}$ in (16b). How does labeling take place in cases like these?

Here, potentially relevant is the fact that a phrase with a Case suffix never “projects,” that is, never provides the label for a larger constituent. The subject of a sentence typically is in nominative, and does not provide the label for the sentence. The PP in (19b) is in genitive, and does not determine the label of YP. Then, the function of suffixal Case seems to be to make a phrase invisible for labeling. Or more generally, it can be hypothesized that Case makes αP opaque for search. When one searches for a label in (20), Case makes αP opaque and consequently, βP (or its head) serves as the unique label provider for γ .

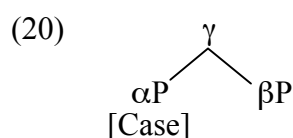

The hypothesis that suffixal Case serves as an anti-labeling device seems simplistic, but it has a couple of desirable consequences. First, it makes the analysis of the multiple occurrences of Case markers in Japanese complete. Recall that Japanese allows multiple nominative subjects because their Cases can be valued as in (21).

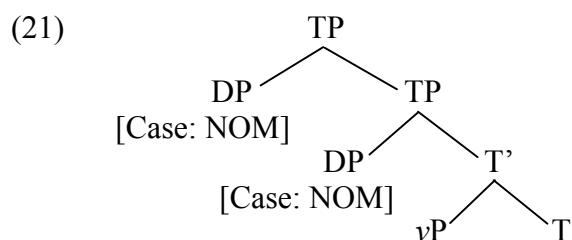

The two subjects in (21) can both probe T and have their Cases valued as nominative. The remaining problem was why this is not possible, for example, in English. Here, the hypothesis on labeling just presented makes the desirable distinction between Japanese and English. If suffixal Case in Japanese serves as an anti-labeling device, then the two TPs in (21) are appropriately labeled. T' is the only visible element for the lower TP and the lower TP is the only visible element for the higher TP. On the other hand, labeling fails with multiple nominative subjects in English as illustrated in (22).

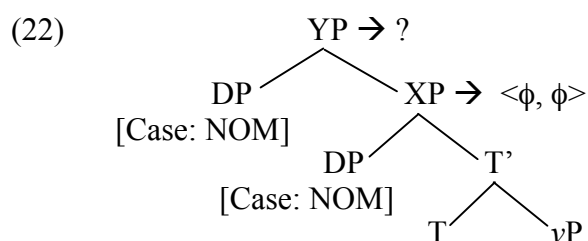

XP is labeled as $\langle \phi, \phi \rangle$ through feature sharing. However, since only the lower subject values the ϕ -features of T, there is no ϕ -feature sharing between the higher subject and T. Consequently, YP cannot be labeled although the higher subject can have its Case valued as nominative. Thus, it is correctly predicted that multiple nominative subjects are illicit in English.

Multiple accusative objects receive the same analysis. They occur in the structure in (23).

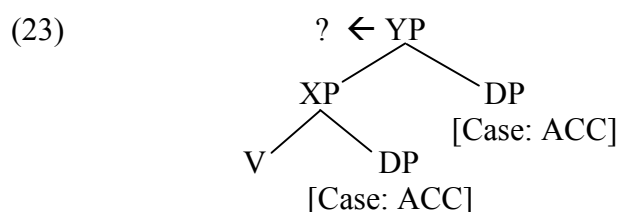

V, being a head, provides the label of XP. In the case of English, XP may also be labeled as $\langle \phi, \phi \rangle$ because the lower object values the ϕ -features of V, inherited from v . The higher object can have its Case valued as accusative. However, YP fails to be labeled in the absence of suffixal Case because there is no ϕ -feature sharing between V and the higher object.

The second consequence of the hypothesis is that it provides an explanation for why Japanese, as opposed English, allows DP scrambling. Although the precise analysis for scrambling is controversial, it is clear that it is neither operator movement nor A-movement.⁷ The following example illustrates this property:

- (24) a. Minna-ga [_{CP} Hanako-ga dono hon-o eran-da ka] sir-ita-gat-te i-ru
 all-NOM H.-NOM which book-ACC choose-Past Q want.to.know-Pres.
 ‘Everyone wants to know which book Hanako chose.’

- b. Dono hon-o monna-ga [_{CP} Hanako-ga eran-da ka] sir-ita-gat-te i-ru
-

In (24b), the wh-phrase, *dono hon-o* ‘which book-ACC’, is scrambled out of the embedded CP, where it takes scope. Yet, the example is perfectly grammatical and is interpreted exactly as (24a) without scrambling. The movement cannot be A-movement because it is clearly in violation of the locality imposed on A-movement. It cannot be operator movement either because if it were, the scrambled phrase should take scope at the final landing site.

It was already briefly discussed how labeling takes place with operator movement and A-movement. Labeling of the constituent formed by operator movement is accomplished by the sharing of an operator/clause-type feature, as illustrated in (25a) for wh-movement.

- (25) a. Operator movement

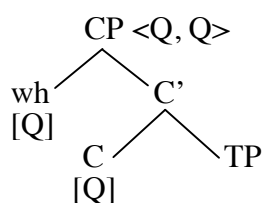

- b. NP-movement

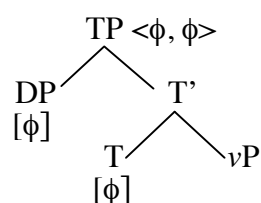

In the case of A-movement, ϕ -feature sharing is important as shown in (25b). As scrambling is neither, it is reasonable to assume that it is “pure internal merge” without feature sharing,

⁷ See, in particular, Saito (1989, 2003) and Webelhuth (1989) for relevant discussion. It should be noted here that scrambling may not be a uniform phenomenon across languages. Here, I am concerned with Japanese/Korean-type scrambling.

along the lines suggested in Tada (1993) and Saito (2003), for example. Then, it forms (26a) when it targets CP and (26b) when it internally merges with TP.

(26) scrambling



By hypothesis, YP in (26a) and XP in (26b) cannot be labeled by feature sharing. Hence, scrambling should be illicit unless there is another way to label the formed object. Japanese Case, if it is indeed an anti-labeling device, makes this labeling possible. Suppose that α P is the object. Then it accompanies an accusative Case marker and hence, is invisible for labeling. Then, CP provides the label for YP in (26a) and TP for XP in (26b). Hence, the hypothesis on Japanese Case predicts correctly that the language allows DP scrambling.

I presented a hypothesis that the function of Case in Japanese is to make a phrase invisible for labeling, and showed that it makes the analysis for the multiple occurrences of Case markers complete and provides an explanation for DP scrambling. Before closing this section, I suggest an extension of this hypothesis on Case to predicate inflection.

It should be noted first that scrambling in Japanese is not limited to DPs. For example, PPs and adverbs can be scrambled, as shown in (27) and (28) respectively.

(27) a. Hanako-ga tosyokan-kara hon-o karidasi-ta
 H.-NOM library-from book-ACC check.out-Past
 ‘Hanako checked out a book from the library.’

b. Tosyokan-kara Hanako-ga hon-o karidasi-ta

(28) a. Taroo-wa sizuka-ni kaet-ta
 T.-TOP quietness-Cop. leave-Past
 ‘Taroo left quietly.’

b. Sizuka-ni Taroo-wa kaet-ta

PP scrambling is not surprising. As noted above, PPs require genitive Case within nominal

projections. Another relevant example is shown in (29).

- (29) [Hanako-no [tosyokan-kara-no [hon-no karidasi]]]
 H.-GEN library-from-GEN book-GEN check.out
 ‘Hanako’s check-out of a book from the library’

This suggests that PPs accompany Case features and they are valued as genitive, say, by N or D, within noun phrases. If this is the case, the PP in (27) should also have a Case feature although it is not phonetically realized. The Case, then, accommodates the labeling of the root in (27b).

Adverb scrambling is potentially more interesting. The adverb in (28), *sizuka-ni* ‘quietness-Cop.’, belongs to the category ‘nominal adjective’ (NA) in traditional grammar and assumes a preverbal form. Predicates in Japanese and Korean exhibit inflection into various forms, including conclusive, prenominal and preverbal. The distinction is lost in part in modern Japanese, but it is still observed with NAs as shown in (30).

- (30) a. Kono heya-wa sizuka-da (conclusive)
 this room-TOP quietness-Cop.
 ‘This room is quiet’
- b. sizuka-na heya (prenominal)
 quietness-Cop. room
 ‘a quiet room’
- c. Taroo-wa sizuka-ni kaet-ta (preverbal)
 T.-TOP quietness-Cop. leave-Past
 ‘Taroo left quietly’

Extending the paradigm beyond predicates, An (2009) suggests that genitive in Korean is not Case in the usual sense but creates prenominal forms of DPs and PPs.⁸ This insight on the parallelism between predicate inflection and Case can be restated as the hypothesis that inflection on predicates serves the same role as Case markers in Merge, that is, it is an anti-labeling device. This is reasonable as inflected phrases, just like Case marked phrases, never “project.”

⁸ See also Sells (1995) for much relevant discussion. Okutsu (1974) also proposes that *no* on DPs is in some cases not genitive Case but the prenominal form of the copula *da*.

The idea can be formally implemented with the feature λ that makes a constituent opaque for search and is realized as Case markers on DPs/PPs and as inflection on predicates. Suppose that αP is a predicate. Then, its λ -feature is valued as conclusive, prenominal and preverbal by C, D/N and v/V respectively as illustrated in (31).

- (31) a. conclusive:
- $$\begin{array}{c} \text{CP} \\ \swarrow \quad \searrow \\ \alpha P \quad C \\ [\lambda: \text{conclusive}] \end{array}$$
- b. prenominal:
- $$\begin{array}{c} \text{D/NP} \\ \swarrow \quad \searrow \\ \alpha P \quad \text{D/N(P)} \\ [\lambda: \text{prenominal}] \end{array}$$
- c. preverbal:
- $$\begin{array}{c} v/\text{VP} \\ \swarrow \quad \searrow \\ \alpha P \quad v/V(\text{P}) \\ [\lambda: \text{preverbal}] \end{array}$$

On the other hand, if αP is a DP or a PP, its λ -feature is valued as nominative, genitive and accusative by T, N/D and V respectively. Given this generalization of Case to λ -feature, the case of adverb scrambling in (28), repeated below in (32), can be accommodated.

- (32) a. Taroo-wa sizuka-ni kaet-ta
 T.-TOP quietness-Cop. leave-Past
 ‘Taroo left quietly.’

- b. Sizuka-ni Taroo-wa kaet-ta
- 

As the scrambled adverb, *sizuka-ni* ‘quietly’, has a λ -feature that is realized as preverbal inflection, it is invisible in labeling. As a result, the root in (32b), formed by the internal merge of the adverb, receives its label from the target TP.

3. The Labeling of Lexical Complex Verbs

In this section, I present independent evidence for the hypothesis that predicate inflection serves as an anti-labeling device. Recall that Chomsky (2013) considers the three cases in (16), repeated below in (33), with respect to labeling.

- (33) a. $\gamma = \{H, \alpha P\}$
 b. $\gamma = \{\alpha P, \beta P\}$
 c. $\gamma = \{H_1, H_2\}$

Labeling fails in (33c) as well as in (33b) unless it is accomplished by an independent mechanism such as feature sharing. According to the hypothesis presented in the preceding section, predicate inflection provides another mechanism to make (33c) possible. That is, it predicts that labeling can take place successfully in the following configuration:

- (34) $\gamma = \{V\text{-inflection}, V\}$

As the inflected verb is invisible, the other verb determines the label of γ . I argue in this section that this prediction is borne out by a specific kind of verbal compounds in Japanese, which Kageyama (1993) calls lexical complex verbs.

Japanese has various kinds of complex verbs (verbal compounds), and Kageyama (1993) classifies them into three types. The first kind, called syntactic complex verbs, is instantiated in (35).

- (35) a. Hanako-ga Taroo-ni wani-o tabe-sase-ta
 H.-NOM T.-DAT alligator-ACC eat-make-Past
 ‘Hanako made Taroo eat alligator meat.’
 b. Taroo-ga wani-o tabe-hazime-ta
 T.-NOM alligator-ACC eat-start-Past
 ‘Taroo started to eat alligator meat.’

It has been known that each of the constituent verbs of a compound of this type projects its own VP in the syntax. Thus, *sase* ‘cause’ in (35a) takes a *vP* complement with the verb *tabe* ‘eat’.⁹ The compound, then, is formed either by incorporation or by morphological merger. Kageyama employs the pro-VP (or pro-*vP*) form, *soo s* ‘do so’, to present evidence for this analysis. The pro form can substitute for the embedded VPs (or *vPs*) in (35), as shown in (36).

⁹ See Kuroda (1965a) and Oshima (1979) for the “biclausal” analysis of causative sentences in Japanese. The *vP* complementation analysis is proposed, for example, in Murasugi and Hashimoto (2004).

(36) a. Hanako-ga Taroo-ni soo s-ase-ta (cf. (35a))

H.-NOM T.-DAT so do-make-Past

‘Hanako made Taroo do so.’

b. Taroo-ga soo si-hazime-ta (cf. (35b))

T.-NOM so do-start-Past

‘Taroo started to do so.’

The second kind, according to Kageyama (1993), is formed in the lexicon by operations on the lexical-conceptual structure. Let’s call complex verbs of this type LCS compounds. Typical examples are shown in (37).

(37) a. Hanako-ga Taroo-o heya-ni oi-kon-da

H.-NOM T.-ACC room-in chase-KOM-Past

‘Taroo was chased by Hanako into the room.’

b. Taroo-ga kawa-ni tobi-kon-da

T.-NOM river-to jump-KOM-Past

‘Taroo jumped into the river.’

c. Osensui-ga umi-ni nagare-kon-da

contaminated.water-NOM ocean-to flow-KOM-Past

‘Contaminated water flowed into the ocean.’

In this case, the verbal compound projects a single VP, and hence, *soo s* ‘do so’ cannot substitute for the first verb and its arguments.

(38) *Taroo-ga (kawa-ni) soo si-kon-da (cf. (37b))

T.-NOM river-to so do-KOM-Past

‘Taroo did so (into the river).’

The second verb, *kom*, appears only as a verbal suffix and does not have an argument structure of its own.¹⁰ The first verbs in (37) indicate motions of objects, *Taroo* in (37a, b) and *osensui* ‘contaminated water’ in (37c). Kageyama states that *kom* adds the meaning that the object moves into the location specified by the goal PP.

There is a third type of complex verbs, which Kageyama (1993) calls lexical complex

¹⁰ There is a homophonous verb *kom*, which means ‘be or become crowded’.

verbs and examines in most detail. Examples are shown in (39).

- (39) a. Hanako-ga Taroo-o osi-taosi-ta
 H.-NOM T.-ACC push-make.fall-Past
 ‘Hanako pushed Taroo and made him fall down.’
- b. Taroo-ga ana-ni suberi-oti-ta
 T.-NOM hole-into slip-fall-Past
 ‘Taroo slipped and fell into a hole.’

These complex verbs, unlike LCS compounds, consist of two verbs with their own argument structures. The component verbs in (39), *os* ‘push’, *taos* ‘cause to fall down’, *suber* ‘slip’, and *oti* ‘fall’, can all be employed independently as verbs. Yet, lexical complex verbs project single VPs unlike syntactic complex verbs. Thus, *soo s* ‘do so’ substitution fails, as shown in (40).

- (40) a. *Hanako-ga (Taroo-o) soo si-taosi-ta (cf. (39a))
 H.-NOM T.-ACC so do-make.fall-Past
 ‘Hanako did so and made (Taroo) fall down.’
- b. *Taroo-ga (ana-ni) soo si-oti-ta (cf. (39b))
 T.-NOM hole-into so do-fall-Past
 ‘Taroo did so and fell into a hole.’

Given that lexical complex verbs project single VPs, Kageyama (1993) proposes that they are formed in the lexicon. More specifically, he proposes that they are formed by argument identification and argument structure inheritance, as illustrated in (41) for (39a).

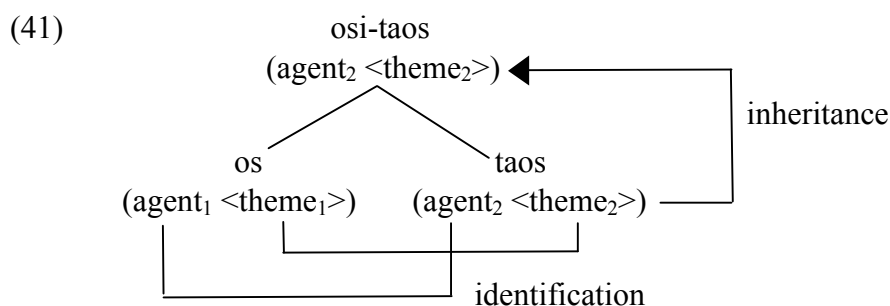

Both *os* ‘push’ and *taos* ‘cause to fall down’ take an agent and a theme as their arguments. The two agents and the two themes are identified by argument identification. Then, the compound inherits the argument structure of *taos*, reflecting the head-final nature of Japanese

morphology.

Kageyama (1993) points out an outstanding property of these lexical complex verbs. That is, if one of the component verbs is unaccusative, so should be the other one. He presents (42) as a language-specific constraint on lexical complex verbs.

(42) The transitivity harmony principle: In a lexical complex verb V_1+V_2 , V_1 and V_2 must be consistent in the presence/absence of an external argument.

This allows the combinations in (43).

- (43) a. transitive-transitive: hiki-nuk (pull-pull.out), nigiri-tubus (grasp-crash), tataki-otos (knock-drop), kiri-tor (cut-remove), uke-tome (receive-catch)
- b. unergative-unergative: hasiri-yor (run-go.close.to), tobi-ori (jump-go.down), kake-nobor (run-climb), aruki-mawar (walk-go.around), mure-tob (form.a.flock-fly)
- c. unaccusative-unaccusative: suberi-oti (slip-fall), ukabi-agar (float-rise), umare-kawar (be.born-change), huri-sosog (fall-flow)
- d. transitive-unergative: moti-aruk (carry-walk), sagasi-mawar (look.for-go.around), mati-kamae (wait-hold)
- e. unergative-transitive: naki-haras (cry-make.swollen), nori-kaer (ride-change), nomi-tubus (drink-waste), odori-akas (dance-stay.up.all.night)

Some examples that are in conflict with (42) are shown in (44).

- (44) a. unaccusative-transitive: *ukabi-mi (float-see), *oti-kakus (fall-hide)
- b. transitive-unaccusative: *osi-taore (push-fall), *nomi-yow (drink-get.drunk)
- c. unergative-unaccusative: *asobi-oti (play-fall), *hasiri-korob (run-tumble)
- d. unaccusative-unergative: *oti-ori (fall-go.down), *nagare-oyog (be.carried-swim)

Note that there is nothing clearly wrong with sentences like (45a, b) semantically.

- (45) a. *Taroo-ga kuzira-o ukabi-mi-ta
 T.-NOM whale-ACC float-see-Past
 ‘A whale came to the surface and Taroo saw it.’

- b. *Hanako-ga Taroo-o osi-taore-ta
 H.-NOM T.-ACC push-fall-Past
 ‘Hanako pushed Taroo and he fell down.’

These examples and more generally (42) demand an explanation. As it is inconceivable that Japanese speakers acquire (42) through experience, it should be explained as a consequence of the basic properties of lexical complex verbs.¹¹

A clue for the explanation can be found in Kageyama’s argument identification illustrated in (41). What it states for the example is that the subject is interpreted as the agent and the object as the theme of both *os* ‘push’ and *taos* ‘cause to fall down’. This amounts to saying that both V_1 and V_2 theta-mark the arguments. Kageyama, in fact, points out that the arguments must satisfy the selectional requirements not only of V_2 but also of V_1 . His examples are shown in (46) and (47) with slight modification.

- (46) a. Tuta-ga boo-ni maki-tui-ta
 ivy-NOM stick-to wind-attach-Past
 ‘An ivy twined around the stick.’

- b. Abura-ga kabe-ni simi-tui-ta
 oil-NOM wall-to soak-attach-Past
 ‘The wall was stained with oil.’

- (47) a. *Tuta-ga boo-ni simi-tui-ta
 ivy-NOM stick-to soak-attach-Past
 ‘The stick was stained with a ivy.’

- b. *Abura-ga kabe-ni maki-tui-ta
 oil-NOM wall-to wind-attach-Past
 ‘The oil twined around the wall.’

¹¹ The generalization in (42) has been discussed extensively in the literature since it was proposed. Yumoto (1997) and Matsumoto (1998), for example, present detailed semantic analyses for lexical complex verbs and point out some potential counter-examples to the generalization. However, as Kageyama (1999) notes, those examples, even if they are indeed problematic, are quite limited and (42) clearly expresses an overwhelming tendency. See also Saito (2014b), which compares Japanese lexical complex verbs with compound verbs in Chinese and resultative serial verbs in Edo, for relevant discussion.

In all of these examples, V_2 is *tuk* ‘attach’. (47a) is ungrammatical because an ivy cannot soak into a stick, and (47b) because oil cannot twine around a wall.

This indicates that V_1 and V_2 both s-select the arguments as illustrated in (48b) for the object of (39a), repeated in (48a).¹²

- (48) a. Hanako-ga Taroo-o osi-taosi-ta
 H.-NOM T.-ACC push-make.fall-Past
 ‘Hanako pushed Taroo and made him fall down.’

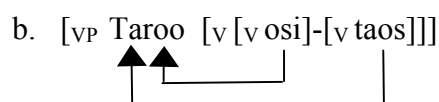

Or more generally, the component verbs of a lexical complex verb are visible in the syntax and participate in selectional relations. This in turn implies that these verbs must also be in proper selectional relations with v as illustrated in (49).

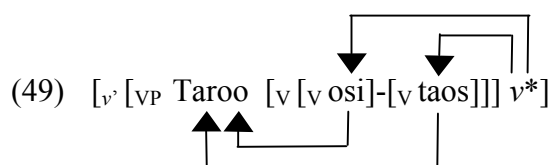

Then, the generalization in (42) follows. It is widely assumed since Chomsky (1995) that v comes in two varieties, v^* and v . v^* selects transitive/unergative verbs and hosts an external argument, whereas v selects unaccusatives. Hence, when a transitive/unergative verb and an unaccusative verb form a lexical complex verb, the selectional requirement of v^*/v necessarily fails. If v^* appears in the structure, the unaccusative verb violates its selectional requirement. If v appears instead of v^* , it is incompatible with the transitive/unergative verb. Thus, Kageyama’s transitivity harmony is derived.

This analysis, if correct, suggests that lexical complex verbs are formed in the syntax. An LCS compound, formed in the lexicon, should select arguments as a single verb, as in (50).



¹² A doubt was raised on the theta-criterion in Fn.5 on the basis that a single theta-role can be assigned to two DPs. (48b) is in conflict with the theta-criterion in the other direction. A DP receives theta-roles from two verbs.

This is not the case with lexical complex verbs. At the same time, lexical complex verbs project single VPs unlike syntactic complex verbs. This leads to the hypothesis that they are formed by direct merger of two verbs as illustrated in (51) for (48).

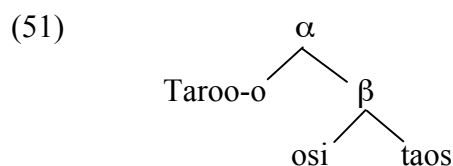

Two conditions must be satisfied for this to be possible. First, morphology must be able to interpret β as a word. Second, α and β must be successfully labeled. These conditions are met, it seems, because of the form of the first verb, *os* ‘push’. The first verb in a lexical complex verb is always in preverbal form, which is derived by suffixing /i/ to the stem. The suffix is deleted when the stem ends in a vowel. Some examples are shown in (52).

- (52) a. *os-i* ‘push’ + *taos* ‘make.fall’, *suber-i* ‘slip’ + *oti* ‘fall’
 b. *mure* ‘form.a.flock’ + *tob* ‘fly’, *umare* ‘be.born’ + *kawar* ‘change’

The first verb of LCS compounds assumes the same form, as illustrated in (53) for the examples in (37).

- (53) *ow-i* ‘chase’ + *kom* ‘KOM’,¹³ *tob-i* ‘jump’ + *kom* ‘KOM’, *nagare* ‘flow’ + *kom* ‘KOM’

Given this, morphology should have no problem interpreting β as a compound.

Further, the preverbal form of the first verb, by hypothesis, makes the labeling of β possible, as shown in (54).

- (54) $\beta = \{V\text{-inflection}, V\}$ or more precisely, $\beta = \{V [\lambda: \text{preverbal}], V\}$

Since the preverbal inflection on the first verb makes it invisible for labeling, the second decides the label of β . This means that the labeling of β is done in exactly the same way as in the examples of VP coordination in (55).

- (55) a. *Hanako-wa itumo* [_{VP} *teeburu-o os-i*], [_{VP} *kabin-o taos*]-u
 H.-TOP always table-ACC push vase-ACC make.fall-Pres.
 ‘Hanako always pushes the table and makes the vase fall.’

¹³ /w/ is deleted before /i/. So, the surface form is [oi + kom].

- b. Taroo-wa [_{VP} suber-i], [_{VP} ana-ni oti]-ta (cf. (39b))
 T.-TOP slip hole-in fall-Past
 ‘Taroo slipped, and fell into a hole.’

These examples contain {VP, VP}, but there is no problem with labeling as the first VP accompanies preverbal inflection.¹⁴ Finally, the labeling of α is straightforward as the object, *Taroo-o* ‘Taroo-ACC’, accompanies a Case marker and hence is invisible for labeling.

I argued in this section that Japanese allows formation of compound verbs by direct merger in the syntax because preverbal inflection accommodates the labeling of the formed object. The analysis of lexical complex verbs with direct merger yields the transitivity harmony generalization in (42) as a consequence of the selectional requirements of v^*/v . If it is on the right track, it provides additional evidence that inflection in Japanese serves as an anti-labeling device, and shows that labeling is an important factor in at least some cases of compound formation as well.

4. Parameters on Argument Ellipsis

I turn to argument ellipsis in this section. I first survey the phenomenon and briefly discuss the hypothesis I entertained in Saito (2007) on what makes argument ellipsis possible. Then, I present an alternative based on Richards’ (2003) proposal that an elided constituent counts as a head in syntactic computation and also on the conclusion in the preceding sections that suffixal Case (and predicate inflection) serve as anti-labeling devices.

4.1. Argument Ellipsis with the Absence of ϕ -feature Agreement

The discussion on argument ellipsis in Japanese (and Korean) started with examples like (6), repeated below as (56).

¹⁴ (48a) is in fact construed as an example of VP coordination as in (i) when a pause is placed between the two verbs.

- (i) Hanako-wa itumo [_{VP} Taroo-o os-i], [_{VP} pro taos]-u
 H.-TOP always T.-ACC push make.fall-Pres.
 ‘Hanako always pushes Taroo and makes him fall.’

- (56) a. Taroo-wa itumo zibun-no hakaseronbun-o inyoosu-ru
 T.-TOP always self-GEN dissertation-ACC cite-Pres.
 ‘Taroo always cites his Ph.D. dissertation.’
- b. Demo, Ziroo-wa zenzen [e] inyoosi-na-i
 but Z.-TOP at.all cite-not-Pres.
 ‘But Ziroo does not cite (his Ph.D. dissertation) at all.’
- c. Demo, Ziroo-wa zenzen sore-o inyoosi-na-i
 but Z.-TOP at.all it-ACC cite-not-Pres.
 ‘But Ziroo doesn’t cite it at all.’

As (56b) indicates, Japanese has null objects, which were analyzed as *pro* since Kuroda (1965b). Otani and Whitman (1991), however, point out that the analysis is insufficient. (56b), as a sequel to (56a), allows sloppy interpretation of the object, that is, the object can be construed as Ziroo’s dissertation in this example. The overt pronoun in (56c) only has the strict interpretation, which is Taroo’s dissertation. Then, it cannot be assumed that the null object in (56b) is always a pronoun without phonetic content. Given this, Otani and Whitman propose, following Huang’s (1987) analysis of similar examples in Chinese, that (56b) can be an instance of VP-ellipsis with V raising to T out of the elided VP.

Oku (1998) and Kim (1999) show that ellipsis of this kind in Japanese and Korean is more widespread than the VP-ellipsis analysis predicts. Oku, for example, demonstrates that null subjects as well as null objects allow sloppy interpretation. One of his examples is given in (57).

- (57) a. Hanako-wa [_{CP} [_{TP} [zibun-no teian]-ga saiyoos-are-ru] to] omot-te i-ru
 H.-TOP self-GEN proposal-NOM accept-Pass.-Pres. COMP think-Pres.
 ‘Hanako thinks that her proposal will be accepted.’
- b. Demo, Taroo-wa [_{CP} [_{TP} [e] saiyoos-are-ru] to] omot-te i-na-i
 but T.-TOP accept-Pass.-Pres. COMP think-not-Pres.
 ‘But Taroo doesn’t think that her/his proposal will be accepted.’

The embedded subject in (57b) can be construed as Taroo’s proposal, which indicates that it allows sloppy interpretation. A null subject, however, cannot be produced with VP-ellipsis. Oku, then, concludes that arguments, such as the object and the subject, can be directly elided

in Japanese.¹⁵

Once it is established that Japanese and Korean allow argument ellipsis, the next question to be addressed is what makes argument ellipsis possible in these languages in distinction with others. Oku (1998) already takes up this question, but I briefly go over the hypothesis presented in Saito (2007) here. The hypothesis is based on two assumptions. One is Oku (1998) and Shinohara's (2006) proposal that elided arguments are interpreted through LF copying and the other is Chomsky's (2008) analysis of ϕ -feature agreement and Case valuation.

Let us first consider the following example, which shows that object ellipsis is impossible in English:

- (58) a. John always cites [_{DP} his dissertation]
 b. *But Bill doesn't cite [*e*]

By hypothesis, the missing object in (58b) is interpreted by copying the object of (58a) into its position at LF, as illustrated in (59a).

(59) a. English

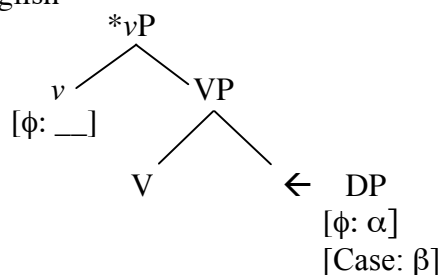

b. Japanese

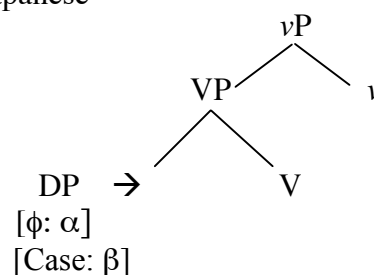

The Case feature of the object DP of (58a), however, is already valued, and the copied DP does not have any unvalued feature. Then, given Chomsky's (2008) activation condition, v in (58b) cannot enter into Agree relation with the copied DP and its ϕ -features fail to be valued. This constitutes an account for why object ellipsis or more generally, argument ellipsis is impossible in English. What makes the derivation of (58b) crash is the failure of the ϕ -features of v to be valued. Then, there should be no problem if v lacks ϕ -features to begin with, as illustrated in (59b). In other words, the LF copying of a DP from the preceding discourse into an argument position should be allowed if a language lacks ϕ -feature agreement. Thus, the account also predicts correctly that argument ellipsis is possible in languages like Japanese and Korean.

¹⁵ See Oku (1998), Kim (1999), Saito (2004), Shinohara (2004) and D. Takahashi (2008), among many others, for more evidence for argument ellipsis.

Şener and D. Takahashi (2010) point out that this hypothesis to link ϕ -feature agreement to the absence of argument ellipsis makes correct predictions for Turkish. The language has null subjects as well as null objects, but only subject agreement. Null objects allow sloppy interpretation, as shown in (60).

(60) a. Can [*pro* anne-si]-ni eleştir-di
 John mother-3SG-ACC criticize-Past
 ‘John criticized his mother.’

b. Mete-yse ___ öv-dü
 Mete-however praise-Past
 ‘Mete, however, praised her/his mother.’

The missing object in (60b) can be construed as Mete’s mother. On the other hand, null subjects only allow strict interpretation as (61) indicates.

(61) a. Can [[*pro* öneri-si]-nin kabul ed-il-eceğ-i]-ni düşün-üyor
 John proposal-3SG-GEN accept do-Passive-NM-3SG-ACC think-Pres.
 ‘John thinks that his proposal will be accepted.’

b. Aylin-se [___ redded-il-eceğ-i]-ni düşün-üyor
 Eileen-however reject-Passive-NM-3SG-ACC think-Pres.
 ‘Eileen, however, thinks that it will be rejected.’

The embedded subject in (61b) can only be John’s proposal, not Eileen’s. Şener and D. Takahashi argue that this follows if the presence of ϕ -feature agreement implies the absence of argument ellipsis.¹⁶

Although the hypothesis is successful to a certain extent on empirical grounds, I believe that there is good reason to pursue an alternative, given the discussion in the preceding sections. As the hypothesis crucially assumes that Japanese and Korean lack ϕ -feature agreement altogether, it raises a question on how Case is valued in these languages. As

¹⁶ The hypothesis has been tested against various languages with mixed and sometimes inconclusive results. Among the relevant works are D. Takahashi (2014), Cheng (2013) and Li (2014) on Chinese, D. Takahashi (2013) on Malayalam, Simpson, et al. (2013) on Bangla, Hindi and Malayalam, and Sato (2015) on Javanese. It is beyond the scope of this paper to discuss these works in any detail. But I touch on some of them in the discussion below where they seem particularly relevant.

repeatedly noted, Chomsky's (2008) analysis of Case valuation as a reflex of ϕ -feature agreement cannot be assumed. I provided an answer to this question in Section 2, adopting Bošković's (2007) proposal. But the proposal dispenses with the activation condition, which plays a crucial role in the hypothesis on argument ellipsis just discussed.¹⁷

As noted, the correlation between ϕ -feature agreement and the absence of argument ellipsis seems to hold at least to some extent. There are also other correlations pointed out in the literature. Cheng (2012) suggests that argument ellipsis is observed only in article-less NP (as opposed to DP) languages in the sense of Bošković (2012). Otaki (2011), extending Neeleman and Szendrői's (2007) discussion on radical pro-drop, proposes that languages with fusional Case morphology lack argument ellipsis. The ultimate goal should be to capture all these correlations to the extent that they are correct. As a first step toward this goal, I pursue a hypothesis on Japanese/Korean argument ellipsis that is based on the labeling algorithm in the following subsection. The hypothesis shares some features with Otaki (2011) as it proposes that suffixal, and hence, non-fusional Case makes argument ellipsis possible.

4.2. Labeling and Ellipsis

Richards (2003) proposes an explanation for the generalization on VP-ellipsis, N'-ellipsis and sluicing presented in Saito and Murasugi (1990) and Lobeck (1990). The crucial idea is that elided constituents count as unanalyzable units and hence as heads in syntactic computation. Although Richards' explanation is based on a revised version of Kayne's (1994) linear correspondence axiom, I restate it in terms of labeling and argue that it successfully accounts for argument ellipsis in Japanese and Korean when combined with the hypothesis that suffixal Case makes a phrase invisible for labeling. At the end, I discuss some complications that arise with the extension of the analysis to other languages, including Turkish and Malayalam.

The generalization that Richards (2003) sets out to explain is given in (62).

(62) Ellipsis: The complement of a functional category F (D, C, or T) can be elided only when F has a specifier, as illustrated below.¹⁸

¹⁷ An empirical problem is also noted in Saito (2007). That is, the hypothesis predicts incorrectly that PP and CP arguments can be elided in English because they do not participate in ϕ -feature agreement.

¹⁸ Saito and Murasugi (1990) and Lobeck (1990) require that there be agreement relation between XP and F. Richards assumes the simpler form of the generalization in (62).

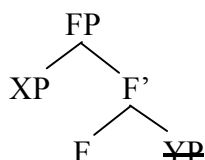

It is well known since Ross (1969) that sluicing requires a wh-phrase in Spec, CP. Thus, the following contrast obtains as an instance of (62):

- (63) a. He bought something, but I don't know [CP what [_{TP} ~~he bought~~]]
 b. *He said that he saw a unicorn, but I don't know [CP if [_{TP} ~~he saw a unicorn~~]]

Equally well known is Jackendoff's (1971) observation that a genitive phrase must be a remnant with N'-ellipsis.

- (64) a. I read Bill's book, but I haven't read [_{DP} Mary's [_{NP} ~~book~~]]
 b. *I want to read the book because I hear good thing about [_{DP} the [_{NP} ~~book~~]]

This contrast, too, falls under the generalization in (62). VP (vP)-ellipsis obtains when the functional head F is T, and in this case, Spec, TP is filled independently because of the EPP.

Here, I take sluicing to illustrate how Richards' (2003) proposal yields the requirement that Spec, CP be filled, postponing the discussion of N'-ellipsis until next section. Sluicing creates the structure in (65) in the absence of Spec, CP, where H is the elided TP.

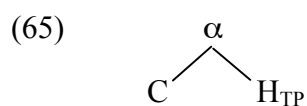

Given Richards' proposal that an elided phrase counts as a head, α fails to be labeled as it consists of two heads. On the other hand, when a wh-phrase is in Spec, CP, the following structure obtains:

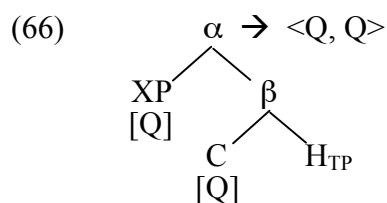

In this case, α is successfully labeled as $\langle \text{Q}, \text{Q} \rangle$ through feature sharing. Thus, the contrast in (63) receives an account based on labeling. It is possible that β need not be labeled because it is an "intermediate projection" and does not contribute to interpretation. I assume for

concreteness that the Q-feature sharing designates C as the provider of label for β .

Let us now consider how this analysis extends to argument ellipsis. Note first that in Japanese and Korean, both the subject and the object accompany suffixal Case, and hence λ -feature. Then, subject ellipsis is represented as in (67), where H is the elided subject.

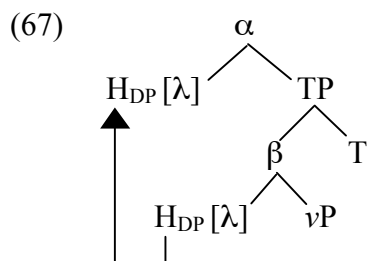

The subject first merges with vP , and then possibly, internally merges with TP.¹⁹ There is no problem with the labeling of β or α because the subject accompanies a λ -feature. vP decides the label of β and TP the label of α . Object ellipsis is even more straightforward.

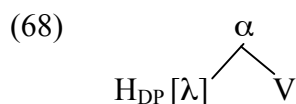

As the elided object has a λ -feature, V provides the label of α .

This analysis successfully accounts for argument ellipsis in Japanese and Korean. These languages allow both subject ellipsis and object ellipsis because subjects and objects accompany λ -features, which are realized as suffixal Cases when overt. It also suggests a possible direction to pursue for the analysis of Turkish. As noted above, Turkish has object ellipsis but no subject ellipsis. And nominative is null whereas accusative is suffixal in the language, as (60a), repeated below as (69), indicates.

- (69) Can [*pro* anne-si]-ni eleştir-di
 John mother-3SG-ACC criticize-Past
 ‘John criticized his mother.’

If the accusative Case marker is a realization of a λ -feature, object ellipsis is accounted for exactly as in Japanese and Korean. Subject ellipsis, on the other hand, fails in the absence of suffixal Case. When an elided subject merges with vP , the configuration in (70) obtains.

¹⁹ The precise derivation depends in part on whether argument ellipsis involves LF copying or PF deletion. I leave the details open as what is important here is that the elided subject merges with vP .

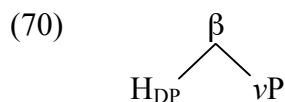

Since the subject is the unique head in the structure, it ends up incorrectly providing the label for β .

A remark is in order here as I have not excluded the possibility that an elided subject internally merges with TP. (70) ceases to be a problem if the subject can internally merge with TP and the label of β can be determined afterwards. vP is the only element β properly contains at that point and hence, it can provide the label for β . In this case, a problem may arise with the labeling of $\{H_{DP}, TP\}$ because H_{DP} is a head, although H_{DP} and TP may share ϕ -features. And independently of this, there is good reason, I believe, to suppose that labeling by a head applies as soon as it is possible. Chomsky (2013) suggests that labeling takes place at the interface (that is, at the point of Transfer). On the other hand, Bošković (2015) argues on both conceptual and empirical grounds that H can label $\{H, \alpha P\}$ as the constituent is formed. One case he mentions is the configuration of head movement as in (71).

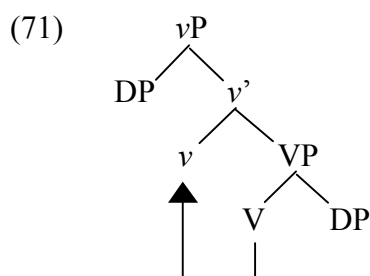

VP must be labeled prior to V-raising because it does not properly contain V afterwards.²⁰ If labeling by a head takes place as soon as it is possible, the analysis for the absence of subject ellipsis illustrated in (70) can be maintained as such.

This analysis extends to Malayalam, which is discussed in detail in D. Takahashi (2013). The language lacks ϕ -feature agreement altogether on the surface, and yet allows only object ellipsis like Turkish. The null object in (72b) can receive sloppy interpretation and be interpreted as Bill's wife.

²⁰ More precisely, Bošković (2015) argues that labeling by a head takes place as Merge forms the constituent whereas labeling by feature sharing applies at the interface if it happens at all. With this proposal, he presents a comprehensive theory of islands based on the anti-locality constraint that internal Merge must cross a labeled phrase. It is important in this theory that VP is labeled when the object internally merges with vP . The reader is referred to the paper for details as the theory includes original proposals including a redefinition of phase.

(72) a. John tan-te bhaarya-ye sneehik'k'unnu
 John self-GEN wife-ACC love
 'John loves his wife.'

b. pakSe Bill [e] weRukk'unnu
 But Bill hate
 'But Bill hates his wife.'

This is consistent with the analysis just presented because accusative Case is suffixal as indicated in (72a). On the other hand, null subjects resist sloppy interpretation as shown in (73).

(73) a. John paRaññu [ten-te makan Microsoft-il jooli ceyy'unnu ennə]
 John said self-GEN son Microsoft-in job do COMP
 'John said that his son was working at Microsoft.'

b. Bill paRaññu [[e] IBM-il jooli ceyy'unnu ennə]
 Bill said IBM-in job do COMP
 'Bill said that he (= Bill) was working at Microsoft.'

The embedded subject in (73b) is interpreted as Bill. D. Takahashi (2013) notes that this is because *pro* in Malayalam is subject to Huang's (1984) generalized control for pronominals and must take the closest c-commanding nominal as its antecedent. The absence of subject ellipsis is expected as nominative is not suffixal.

Finally, it is predicted that languages like English without suffixal Case do not allow argument ellipsis at all. Object ellipsis in those languages yields the structure in (74).

(74)

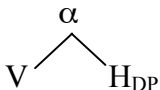

$$\begin{array}{c} \alpha \\ \swarrow \quad \searrow \\ V \quad \quad H_{DP} \end{array}$$

α consists of two heads, and there is no λ -feature to aid labeling. Hence, α fails to be labeled. Thus, the presence of suffixal Case seems to correlate with the possibility of argument ellipsis

in Japanese/Korean, Turkish/Malayalam, and languages with no suffixal Case markers.²¹

However, it should be pointed out that there are remaining issues with the analysis of Turkish, Malayalam and English, and they all suggest that ϕ -feature agreement is after all a factor for argument ellipsis. First, as pointed out by a reviewer, subjects of nominalized clausal complements accompany suffixal genitive Case in Turkish and yet, they cannot be elided. (61), repeated below as (75), in fact illustrates this.

- (75) a. Can [[*pro* öneri-si]-nin kabul ed-il-eceğ-i]-ni düşün-üyor
 John proposal-3SG-GEN accept do-Passive-NM-3SG-ACC think-Pres.
 ‘John thinks that his proposal will be accepted.’
- b. Aylin-se [__ redded-il-eceğ-i]-ni düşün-üyor
 Eileen-however reject-Passive-NM-3SG-ACC think-Pres.
 ‘Eileen, however, thinks that it will be rejected.’

Although the embedded subject in (75a) accompanies the genitive suffix *-nin*, the null embedded subject in (75b) resists sloppy interpretation. Then, ϕ -feature agreement seems to indeed distinguish between Japanese/Korean and Turkish with respect to subject ellipsis, as Şener and D. Takahashi (2010) proposed. I tentatively make the following stipulation to accommodate this case:

- (76) A (suffixal) Case on XP is *not* a realization of λ -feature if it is valued by a head that agrees with the XP in ϕ -features.

The potential problem that arises with English concerns the configuration of object ellipsis in (74). I stated above that α fails to be labeled as it consists of two heads. However, if V inherits ϕ -features from v , as I have been assuming, then there is a possibility that α can be labeled as $\langle \phi, \phi \rangle$ through feature sharing, as illustrated in (77).

- (77)
- $$\begin{array}{c} \alpha \rightarrow \langle \phi, \phi \rangle \\ \swarrow \quad \searrow \\ V \quad H_{DP} \\ [\phi] \quad [\phi] \end{array}$$

²¹ The analysis fits well with the fact that both Turkish and Malayalam are scrambling languages. Since they have suffixal accusative Case markers, object scrambling should not cause any problem with labeling as discussed for Japanese and Korean. But it remains to be seen if scramblings in Turkish and Malayalam are of the same kind as Japanese and Korean. See, for example, Şener (2010), Jayaseelan (2008) and the references cited there for relevant discussion.

I tentatively assume at this point that labeling by feature sharing is limited to cases of $\{\alpha P, \beta P\}$ in order to avoid this undesirable consequence.

The remaining issue with Malayalam has to do with the labeling of sentences (TPs). I suggested above that subject ellipsis is illicit in the language because nominative Case is not suffixal and hence not a realization of the λ -feature. However, Malayalam, unlike Turkish, lacks subject agreement at least on the surface. Then, an issue arises how labeling is done when an overt subject DP merges with TP. D. Takahashi (2013), entertaining the hypothesis of Saito (2007) that ϕ -feature agreement implies the absence of argument ellipsis, suggests that Malayalam after all has abstract subject agreement. This is certainly a possibility because the other languages in the Dravidian family have overt subject agreement. If it is indeed tenable, then $\{DP, TP\}$ is successfully labeled $\langle \phi, \phi \rangle$ as in English and Turkish. This is consistent with the analysis of argument ellipsis presented in this paper. At the same time, it raises a non-trivial learnability issue. How would children acquiring Malayalam find out that there is ϕ -feature agreement in Malayalam? Further investigation is required.

In addition to these empirical problems that arise with the extension of the analysis of argument ellipsis beyond Japanese and Korean, there is a conceptual problem that this paper shares with Bošković (2007). As noted at the outset of this paper, Chomsky proposes that ϕ -feature agreement makes labeling possible and also requires Case, given the activation condition. However, I crucially assumed the analysis of Bošković (2007), which abandons the activation condition, and proposed that suffixal Case as a realization of λ -feature plays an important role in labeling in the absence of ϕ -feature agreement. Then, it remains to be answered what role Case plays in ϕ -feature agreement languages. Once the activation condition is abandoned, non-suffixal Case seems to have no role in the system.

I basically leave these questions for future research. But I offer some speculations in the following section and suggest a possible direction to pursue the conceptual question and the empirical issues with the labeling of sentences (TPs) in Malayalam and the absence of object ellipsis in English.

5. Speculations on Case Feature Sharing

This section is exploratory. I first present evidence that Case valuation results in feature sharing that makes labeling possible. Based on this, I suggest the possibility that sentences (TPs) in Malayalam are labeled $\langle \text{NOM}, \text{NOM} \rangle$. Then, I reconsider the roles of Case and ϕ -feature agreement in derivation, and speculate that ϕ -feature agreement, when present, is a

condition on Case valuation. Secondly, I briefly go over and adopt Chomsky's (2014) idea that there are weak heads, including roots of verbs, that cannot provide labels. This, I suggest, leads to a more principled account for why object ellipsis is not allowed in English, for example.

5.1. Labeling by Case Feature Sharing

In the preceding section, I discussed a restatement of Richards' (2003) analysis of (62), repeated below as (78), in terms of labeling.

- (78) Ellipsis: The complement of a functional category F (D, C, or T) can be elided only when F has a specifier, as illustrated below.

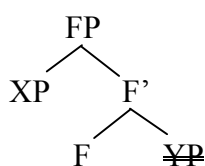

I used sluicing for illustration there, but let us now turn to N'-ellipsis. As shown in (79a), labeling fails with N'-ellipsis when the specifier is absent.

- (79) a.
$$\begin{array}{c}
 \alpha \\
 \swarrow \quad \searrow \\
 \text{D} \quad \text{H}_{\text{NP}}
 \end{array}$$
 b.
$$\begin{array}{c}
 \alpha \\
 \swarrow \quad \searrow \\
 \text{DP} \quad \beta \\
 \quad \quad \swarrow \quad \searrow \\
 \quad \quad \text{D} \quad \text{H}_{\text{NP}}
 \end{array}$$

(79b) is the structure of well-formed N'-ellipsis. If it is to be analyzed in parallel with sluicing, DP and D share a feature f and as a result, α is successfully labeled as $\langle f, f \rangle$. But what can the feature f be here? One possibility is that there is abstract ϕ -feature agreement between DP and D. But this does not extend straightforwardly to N'-ellipsis in Japanese.

It is argued in Saito and Murasugi (1990) that examples such as the following instantiate N'-ellipsis in Japanese:

- (80) a. Amerika-gun-no Bagdadaddo-no bakugeki-wa [_{DP} Igirisu-gun-no [_{NP} e]]-yori
 U.S.-force-GEN Baghdad-GEN bombing-TOP U.K.-force-GEN -than
 hagesi-katta
 intense-Past
 'U.S. force's bombing of Baghdad was more intense than U.K. force's.'

- b. Rooma-no hakai-wa [DP Kyooto-no [NP e]]-yori hisan-dat-ta
 Rome-GEN destruction-TOP Kyoto-GEN -than misery-Cop.-Past
 ‘Rome’s destruction was more miserable than Kyoto’s.’

On piece of evidence is the pattern adjuncts exhibit.

The remnant is a subject in (80a) and an object in (80b). But the distribution of genitive Case is not limited to subjects and objects. As noted in Section 2.1, any DP or PP within projections of N and D accompanies a genitive Case marker. (81) shows that this is true also of adjuncts.

- (81) a. ame-no hi
 rain-GEN day
 ‘a rainy day’
- b. san-satu-no hon
 three-Classifier-GEN book

Interestingly, these adjuncts cannot be remnants with N’-ellipsis as shown in (82).²²

- (82) a. *Saikin-wa ame-no hi-ga [DP hare-no [NP e]]-yori oo-i
 recently-TOP rain-GEN day-NOM fine.weather-GEN -than plentiful-Pres.
 ‘Recently, there are more rainy days than clear days.’
- b. *Taroo-wa issyuukan-ni san-satu-no hon-o yom-u-ga
 T.-TOP one.week-in three-Classifier-GEN book-ACC read-Pres.-though
 Hanako-wa [DP go-satu-no [NP e]]-o yom-u
 H.-TOP five-Classifier-GEN -ACC read-Pres.
 ‘Though Taroo reads three books in a week, Hanako reads five.’

This is precisely what is expected with the N’-ellipsis analysis. It is known independently that subjects and objects, but not adjunct, can internally merge with DP. Thus, the following contrast obtains:

- (83) a. [DP the barbarians’ [NP destruction of the city then]]
 b. [DP the city’s [NP destruction then]]

²² Watanabe (2010) argues that the numeral classifier phrase in (81b) is not an adjunct and offers an alternative analysis for the ungrammaticality of (82b). See also Saito (2015) for relevant discussion.

c. *[_{DP} then's [_{NP} destruction of the city]]

The contrast between (80) and (82), then, falls under the generalization in (78).

If Japanese indeed has N'-ellipsis, the Japanese counterpart of (79b), shown in (84), should be allowed.²³

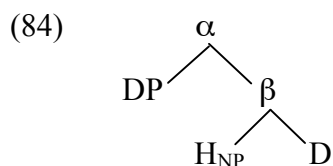

But in this case, it is unlikely that there is ϕ -feature sharing between DP and D. If Japanese lacks ϕ -feature agreement at the sentential level, it does not make much sense to postulate abstract ϕ -feature agreement only within DPs. Then, what is the feature f that is shared by DP and D, and enables α to be labeled? The only possibility that I can think of is Case. Again, any DP or PP within projections of N and D accompanies genitive Case. D in (84), then, values the Case of the DP as genitive. I suggest that this leads to the labeling of α as <GEN, GEN>.

Feature sharing by Case valuation has a number of consequences, which I discuss throughout the rest of this section. First, it makes an alternative analysis of Malayalam sentences (TPs) possible. Recall that there is no overt ϕ -feature agreement and nominative is not suffixal in the language. It was then unclear how sentences are labeled. But if Case valuation aids labeling, derivation in Malayalam can proceed as follows:²⁴

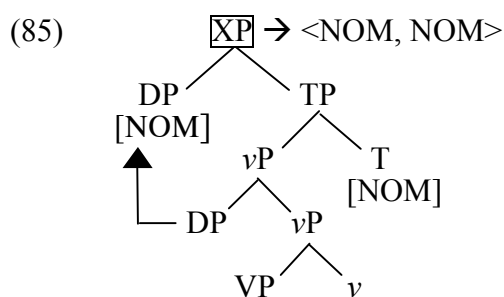

²³ M. Takahashi (2011) develops Bošković's (2012) NP-DP parameter, and proposes an analysis of N'-ellipsis in Japanese, where the functional head in (84) is not D but K(ase). As far as I can see, this, even if it is correct, does not affect the argument to be presented below.

²⁴ This goes well with Pesetsky and Torrego's (2007) proposal that nominative is a Tense feature on DPs. But I leave it for future research to examine the precise implications of the idea for the analysis presented here.

The root can be labeled as <NOM, NOM> after the subject internally merges with TP. Note that subject ellipsis is still ruled out with the assumption that labeling by a head takes place as soon as it can apply. An elided subject, being a head, leads to failure of labeling when it merges with *v*P.

The hypothesis also has potential consequences for the analysis of argument ellipsis in Chinese, another language that lacks ϕ -feature agreement altogether.²⁵ This language, like Turkish and Malayalam, allows object ellipsis but not subject ellipsis, as discussed in detail by D. Takahashi (2014), Cheng (2013) and Li (2014). The following example from Li (2014) demonstrates that a null object allows sloppy interpretation:

- (86) a. Zhangsan [yinwei wo jiao-guo ta de erzi] hen gaoping
 Zhangsan because I taught-ASP his son very happy
 ‘Zhangsan is happy because I have taught his son.’
- b. Lisi [yinwei wo mei jiao-guo (ta de erzi)] hen bu gaoping
 Lisi because I not teach-ASP his son very not happy
 ‘Lisi is not happy because I have not taught his son.’

The elided object in (86b) can be construed as Lisi’s son. (87), also from Li (2014), shows that subject ellipsis does not obtain in Chinese.

- (87) a. Zhangsan [yinwei ziji de/ta de erzi jiao-guo shuxue] hen gaoping
 Zhangsan because self’s his son teach-ASP math very happy
 ‘Zhangsan is happy because his son has taught math.’
- b. Lisi [yinwei e jiao-guo yuyanxue] hen deyi
 Lisi because teach-ASP linguistics very proud
 ‘Lisi is proud because he (= Lisi) has taught linguistics.’

The embedded subject in (87b) takes the matrix subject as its antecedent because of Huang’s (1984) generalized control of pronominals, mentioned above in the discussion of Malayalam.

The peculiarity of Chinese, in the context here, is that it allows object ellipsis even in the absence of suffixal accusative Case marker. But if labeling by Case feature sharing is possible, object ellipsis should be allowed as illustrated in (88).

²⁵ The discussion here applies to Javanese as well, which is examined in Sato (2015).

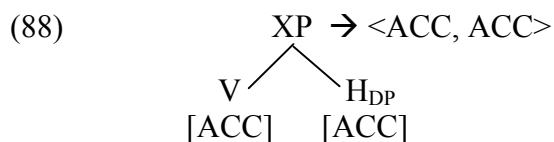

The references mentioned above show that the precise distribution of object ellipsis is quite complex in Chinese, and it is beyond the scope of this paper to discuss this. But there is one fact that suggests that Case indeed plays an important role. Li (2014) points out that complement CP ellipsis is possible only when the matrix verb can alternatively take a DP object. Thus, (89b), with the matrix verb *yiwei* ‘think’, is ungrammatical.

- (89) a. Wo *yiwei* ta hen *congming*
 I think he very smart
 ‘I thought he was very smart.’
- b. Tamen ye *(zhe-me/yang) *yiwei*
 They also so think
 ‘They also thought so.’

This is expected if *yiwei* does not value accusative and hence cannot create the configuration of Case feature sharing. The labeling of sentences as well as the absence of subject ellipsis can be accounted for exactly as in Malayalam. Chinese clearly lacks scrambling, and this too follows from the lack of suffixal accusative Case marker.

It is probably useful at this point to summarize the proposals made so far. Labeling dictates argument ellipsis as well as scrambling. Suffixal Case markers, being realizations of λ -features, license scrambling and make argument ellipsis possible in subject and object positions. This accounts for argument ellipsis in Japanese and Korean as well as object ellipsis in Turkish and Malayalam. Feature sharing by Case valuation allows object ellipsis in Chinese and the labeling of sentences in Malayalam and Chinese. It redundantly accounts for object ellipsis in Japanese, Korean, Turkish and Malayalam, but is not sufficient to explain object scrambling in those languages.

Labeling by Case feature sharing, suggested in this subsection, forces a reconsideration of the account for the absence of object ellipsis in languages like English. This is so because a transitive verb values the accusative Case on the object in English as well and hence, the analysis for object ellipsis in Chinese predicts incorrectly that it should be possible in English. In the following subsection, I suggest an account for the difference between Chinese and

English on the basis of Chomsky's (2014) distinction between strong and weak heads.²⁶ The discussion also sheds new lights on the remaining issue that has to do with the role of Case in ϕ -feature agreement languages. As noted above, once the activation condition is dispensed with and Case is no longer required for ϕ -feature agreement, it is not clear what role Case plays in those languages. I address this first.

5.2. The Absence of Object Ellipsis and the Role of Case in English

As repeatedly noted, Chomsky (2008) maintains with the activation condition that Case is required for and valued through ϕ -feature agreement. But I presented evidence in Section 2 for Bošković's (2007) proposal to dissociate Case valuation from ϕ -feature agreement and to dispense with the activation condition. This raises a fundamental question concerning the role of Case in a derivation in ϕ -feature agreement languages as already mentioned. Why do they require Case? The discussion in the preceding subsection opens up a new direction to pursue this question. If Case valuation makes labeling by feature sharing possible, then English sentences can be labeled as $\langle \text{NOM}, \text{NOM} \rangle$ instead of $\langle \phi, \phi \rangle$ as I suggested for Malayalam. This is illustrated in (90).

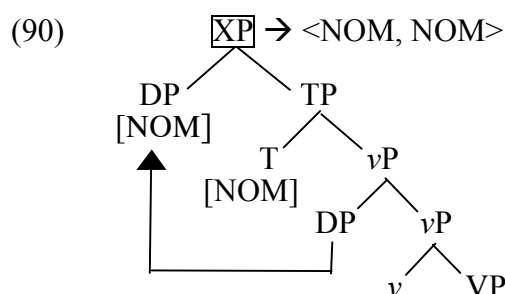

Suppose that this is how $\{\text{DP}, \text{TP}\}$ is labeled. Then Case plays a crucial role in labeling. With this, the question shifts to the role of ϕ -feature agreement. If sentences are labeled as in (90), then what role does ϕ -feature agreement play in a derivation?

Here, I would like to offer a speculation that ϕ -feature agreement, when present, is a

²⁶ A possible alternative approach would be to develop Bošković's (2012) NP-DP parameter. As mentioned above, Cheng (2012) argues that argument ellipsis is possible only in NP languages, that is, those languages without definite articles. These include Chinese and the other languages with argument ellipsis discussed in this paper. If it can be explained in a principled manner why DP is incompatible with argument ellipsis, it would automatically distinguish Chinese and English with respect to object ellipsis.

condition on Case valuation. This can be stated as in (91).²⁷

- (91) A head with ϕ -features can value the Case feature of an XP only if it agrees with the XP in ϕ -features.

(91) solves a new problem created by labeling through Case feature sharing. If sentences can be labeled as in (90), nothing prevents multiple nominative subjects in English, for example. Labeling can take place as shown in (92).

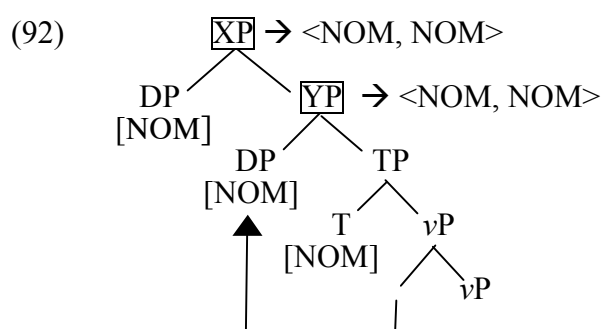

But if Case valuation requires ϕ -feature sharing, the higher subject in (92) cannot be valued for nominative as it does not agree in ϕ -features with T. Thus, multiple nominative subjects are correctly ruled out in English and more generally in subject agreement languages. The speculation, if correct, provides the following picture, where ‘ \rightarrow ’ means ‘requires’:

- (93) Merge \rightarrow Labeling \rightarrow Case (\rightarrow ϕ -feature agreement)

The final issue to be considered is why object ellipsis is not observed in languages such as English. Recall the suggestion that Chinese allows object ellipsis through Case feature sharing as in (88), repeated below in (94).

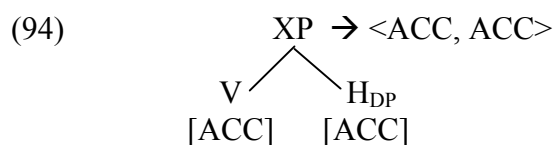

If this is correct, this labeling must fail in those languages without object ellipsis. The desired

²⁷ This can be combined with (76), which stipulates the incompatibility of ϕ -feature agreement and valuation of λ -feature, as in (i).

- (i) A head with ϕ -features can only value a genuine Case feature (as opposed to a λ -feature) and only under ϕ -feature sharing.

result obtains, for example, in the situation where H_{DP} erroneously provides the label for XP . I would like to suggest that this is indeed what happens because V is a weak head in the sense of Chomsky (2014). I first briefly go over Chomsky's (2014) analysis of the EPP before presenting an analysis.

Chomsky (2014) appeals to labeling to explain the EPP, which stipulates that Spec, TP be filled. He entertains the possibility that only strong heads can provide the label for $\{H, \alpha P\}$ and assumes that T is weak in English. Then, no label is provided for $\gamma = \{T_w, vP\}$. But when the subject internally merges with γ , the newly formed object is labeled $\langle \phi, \phi \rangle$ with ϕ -feature sharing, as illustrated in (95a).²⁸

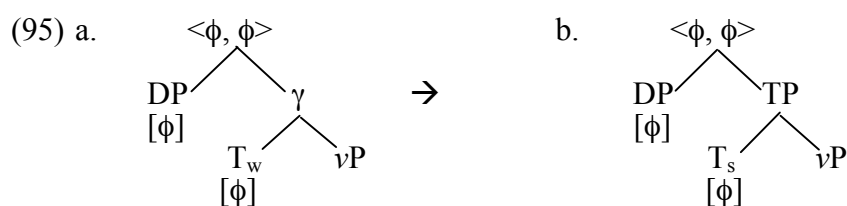

Chomsky hypothesizes further that the feature sharing makes T strong and enables it to provide the label for γ as illustrated in (95b). I assume, as in the discussion of N' -ellipsis above, that the feature sharing designates T as the label provider for γ . Another part of this analysis is that languages are parameterized with respect to whether T is weak or strong. Chomsky suggests that T is strong in null subject languages like Italian and Spanish, and hence they do not require that Spec, TP be filled.²⁹

Given the distinction between strong and weak heads, more patterns of Merge need to be considered for labeling. H_s provides the label for the objects in (96a).

- (96) a. $\{H_s, \alpha P\}, \{H_s, H_w\}$
 b. $\{H_s, H_s\}, \{H_w, H_w\}, \{H_w, \alpha P\}, \{\alpha P, \beta P\}$

The cases in (96b) remain problematic unless labeling is made possible by feature sharing or,

²⁸ The analysis is not affected even if NOM is substituted for ϕ , as far as I can tell.

²⁹ I follow Chomsky and assume that T is strong in some languages. Most languages discussed in this paper allow null subjects, including Japanese, Korean, Turkish, Malayalam and Chinese, and hence, are likely to have strong T . But it needs to be worked out precisely why subjects need not be overt and how nominative is valued postverbally in some languages even if T is strong. The problem becomes more complex under Bošković's (2007) proposal that the subject probes T to have its Case valued as nominative.

if the discussion in the preceding sections is on the right track, by λ -feature which makes an element invisible in labeling. Chomsky suggests (verbal) roots as possible weak heads, in addition to T_w . He adopts Marantz's (1997) proposal that V, for example, enters the derivation as a category neutral root R, and that only after merger with (or raising to) v , its category is determined as V. R becomes strong at that point.

If R is weak, then a different prediction obtains for object ellipsis. When R and an elided object merge, the object incorrectly provides the label for the new object, as shown in (97).



Then, Chinese and English can be distinguished by whether the verb is strong or weak at the point it merges with the object. The basic idea is that there is a null object parameter in parallel with the null subject parameter. While strong T leads to the absence of the EPP, strong verb makes object ellipsis possible.

A possible way to technically implement the difference between strong and weak verbs is by the order of merge among, R, v and the object. The English pattern is illustrated in (98).

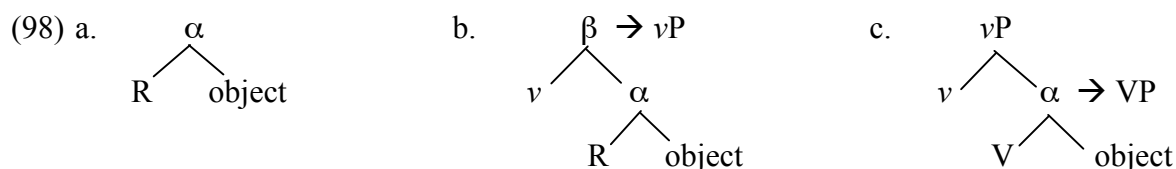

First, R and the object merge. Then, v enters the derivation as in (98b). This determines the category of R and makes it strong.³⁰ As a result, the R, now V, can provide the label of α . The derivation cannot proceed in this way when the object is elided and counts as a head. It provides the label for α in (98a), as indicated in (97), and hence, cannot be interpreted as the object of R. The Chinese pattern, on the other hand, can be as in (99).

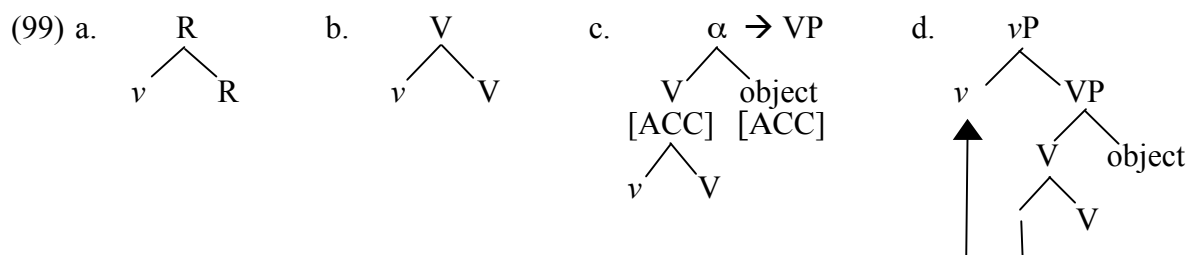

³⁰ Chomsky (2014) proposes that R raises to v and its category is determined at that point. I assume for ease of exposition that the merger of v is sufficient to determine the category of R.

First, ν merges with (or adjoins to) R, and this turns R into V, a strong head. Then, the object merges and ν excorporates to take VP as its complement as in (99c-d). Note that the object merges with V in (99c). Hence, when the object is elided, the newly formed object is $\{H_S, H_S\}$ and can be labeled as $\langle \text{ACC}, \text{ACC} \rangle$.

This account for the distinction between Chinese and English with respect to object ellipsis is still a speculation at this point, and independent evidence is required to make the analysis complete. But it is consistent with the hypothesis pursued in this section that Case valuation creates feature sharing for labeling.

6. Conclusion

In this paper, I pursued how labeling takes place in languages without ϕ -feature agreement. First, adopting Bošković's (2007) proposal that Case valuation is independent of ϕ -feature agreement, I put forward the hypothesis that suffixal Case markers and more generally λ -features in Japanese and Korean make elements opaque for search. On the empirical side, this led to analysis not only for labeling of sentences but also for scrambling and the properties of Japanese lexical complex verbs. Then, I presented a hypothesis on argument ellipsis, relying on the labeling algorithm and Richards' (2003) idea that elided phrases count as heads in syntactic computation. After presenting an analysis for argument ellipsis in Japanese and Korean, I extended it to object ellipsis in Turkish and Malayalam. Finally, I offered some speculations on labeling by feature sharing. Based on N'-ellipsis in Japanese and object ellipsis in Chinese, I suggested that Case feature sharing makes labeling possible and that ϕ -feature agreement, when present, is a condition for Case valuation. The overall conclusion of the paper is that Case plays far more important role in labeling than generally assumed.

In the course of the discussion, I tried to capture, to the extent possible, the cluster of properties that languages like Japanese exhibit. The list in (2) from Hale (1980) and Kuroda (1988) is repeated below in (100).

- (100) a. free word order
 b. wide distribution of null arguments
 c. extensive employment of complex verb-words
 d. multiple occurrences of Case markers

The analysis presented for these phenomena is by no means complete. I only discussed

argument ellipsis with respect to null arguments, and Japanese verbal compounds are not limited to lexical complex verbs. Further, the direction pursued in this paper is obviously one of the many possible ones. Yet, I hope to have demonstrated that labeling provides a new perspective to investigate these phenomena and can even lead to a unified analysis for them.

References

- An, Duk-Ho (2009) "A Note on Genitive Drop in Korean," *Nanzan Linguistics* 5: 1-16.
- Bošković, Željko (2007) "On the Locality and Motivation of Move and Agree: An Even More Minimalist Theory," *Linguistic Inquiry* 38: 589-644.
- Bošković, Željko (2012) "On NPs and Clauses," in Günther Grewendorf and Thomas Ede Zimmermann, eds., *Discourse and Grammar: From Sentence Types to Lexical Categories*, 179-242, Walter de Gruyter, Berlin.
- Bošković, Željko (2015) "On the Timing of Labeling: Deducing Comp-Trace Effects, the Subject Condition, the Adjunct Condition, and Tucking in from Labeling," to appear in this issue.
- Cheng, Hsu-Te Johnny (2013) *Argument Ellipsis, Classifier Phrases, and the DP Parameter*, Ph.D. dissertation, University of Connecticut.
- Chomsky, Noam (1995) *The Minimalist Program*, MIT Press, Cambridge, Mass.
- Chomsky, Noam (2008) "On Phases," in Robert Freidin, Carlos P. Otero and Maria Luisa Zubizarreta, eds., *Foundational Issues in Linguistic Theory: Essay in Honor of Jean-Roger Vergnaud*, 133-166, MIT Press, Cambridge, Mass.
- Chomsky, Noam (2013) "Problems of Projection," *Lingua* 130: 33-49.
- Chomsky, Noam (2014) "POP Extensions," unpublished, MIT.
- Fukui, Naoki (1988) "Deriving the Differences between English and Japanese: A Case Study in Parametric Syntax," *English Linguistics* 5: 249-270.
- Hale, Kenneth (1980) "Remarks on Japanese Phrase Structure: Comments on the Papers on Japanese Syntax," *MIT Working Papers in Linguistics* 2: 185-203.
- Harada, Shin-Ichi (1973) "Counter Equi NP Deletion," *Annual Bulletin* 7: 113-148, The Research Institute of Logopedics and Phoniatics, University of Tokyo.
- Hiraiwa, Ken (2001) "Multiple Agree and the Defect Intervention Constraint," *MIT Working Papers in Linguistics* 40: 67-80.
- Huang, C.-T. James (1984) "On the Distribution and Reference of Empty Pronouns," *Linguistic Inquiry* 15: 531-574.
- Huang, C.-T. James (1987) "Remarks on Empty Categories in Chinese," *Linguistic Inquiry* 18: 321-337.
- Jackendoff, Ray (1971) "Gapping and Related Issues," *Linguistic Inquiry* 2: 21-35.
- Jayaseelan, K. A. (2008) "Topic, Focus and Adverb Positions in Clause Structure," *Nanzan Linguistics* 4: 43-68.

- Kageyama, Taro (1993) *Grammar and Word Formation*, Hituzi Syobo, Tokyo. (in Japanese)
- Kageyama, Taro (1999) *Morphology and Meaning*, Kuroshio Shuppan, Tokyo. (in Japanese)
- Kayne, Richard S. (1994) *The Antisymmetry of Syntax*, MIT Press, Cambridge, Mass.
- Kim, Soowon (1999) "Sloppy/Strict Identity, Empty Objects, and NP Ellipsis," *Journal of East Asian Linguistics* 8. 255-284.
- Kuno, Susumu (1973) *The Structure of the Japanese Language*, MIT Press, Cambridge, Mass.
- Kuroda, S.-Y. (1965a) "Causative Forms in Japanese," *Foundations of Language* 1: 30-50.
- Kuroda, S.-Y. (1965b) *Generative Grammatical Studies in the Japanese Language*, Ph.D. dissertation, MIT.
- Kuroda, S.-Y. (1978) "Case Marking, Canonical Sentence Patterns, and Counter Equi in Japanese," in John Hinds and Irwin Howard, eds., *Problems in Japanese Syntax and Semantics*, 30-51, Kaitakusha, Tokyo.
- Kuroda, S.-Y. (1988) "Whether We Agree or Not," *Linguisticae Investigationes* 12: 1-47.
- Li, Yen-Hui Audrey (2014) "Born Empty," *Lingua* 151: 43-68.
- Lobeck, Anne (1990) "Functional heads as proper governors," *Proceedings of the North East Linguistic Society* 20: 348-362.
- Marantz, Alec (1997) "No Escape from Syntax: Don't Try Morphological Analysis in the Privacy of Your Own Lexicon," *University of Pennsylvania Working Papers in Linguistics* 4.2: 201-225.
- Matsumoto, Yo (1998) "The Combinatory Possibilities in Japanese V-V Lexical Compounds," *Gengokenkyu* 114: 37-83. (in Japanese)
- Miyagawa, Shigeru (2010) *Why Agree? Why Move?: Unifying Agreement-Based and Discourse Configurational Languages*, MIT Press, Cambridge, Mass.
- Murasugi, Keiko and Tomoko Hashimoto (2004) "Three Pieces of Acquisition Evidence for the v-VP Frame," *Nanzan Linguistics* 1: 1-19.
- Neeleman, Ad and Kriszta Szendrői (2007) "Radical Pro Drop and the Morphology of Pronouns," *Linguistic Inquiry* 38: 671-714.
- Oku, Satoshi (1998) *A theory of selection and reconstruction in the minimalist perspective*. Ph.D. dissertation, University of Connecticut.
- Okutsu, Keiichiro (1974) *Generative Japanese Grammar: The Structure of Noun Phrases*, Taishukan, Tokyo. (in Japanese)
- Oshima, Shin (1979) "Conditions on Rules: Anaphora in Japanese," in George Bedell, Eichi Kobayashi and Masatake Muraki, eds., *Explorations in Linguistics: Papers in Honor of Kazuko Inoue*, 423-448, Kenkyusha, Tokyo.
- Otaki, Koichi (2012) "Argument Ellipsis Arising from Non-fusional Case Morphology," in Koichi Otaki, Hajime Takeyasu and Shin-ichi Tanigawa, eds., *Online Proceedings of GLOW in Asia Workshop for Young Scholars 2011*, 247-261, Mie University.
- Otani, Kazuyo and John Whitman (1991) "V-Raising and VP-Ellipsis," *Linguistic Inquiry* 22: 345-358.
- Pesetsky, David and Esther Torrego (2007) "The Syntax of Valuation and the Interpretation of

- Features,” in Simin Karimi, Vida Samiian and Wendy K. Wilkins, eds., *Phrasal and Clausal Architecture*, 262-294, John Benjamins, Amsterdam.
- Richards, Norvin (2003) “Why there is an EPP,” *Gengo Kenkyu* 123: 221-256.
- Rooth, Mats (1992) “A Theory of Focus Interpretation,” *Natural Language Semantics* 1: 75-116.
- Ross, John Robert (1969) “Guess Who?” *Proceedings of Chicago Linguistic Society* 5: 252-286.
- Saito, Mamoru (1982) “Case Marking in Japanese: A Preliminary Study,” unpublished, MIT.
- Saito, Mamoru (1989) “Scrambling as Semantically Vacuous A'-movement,” in Mark R. Baltin and Anthony S. Kroch, eds., *Alternative Conceptions of Phrase Structure*, 182-200, University of Chicago Press, Chicago.
- Saito, Mamoru (2003) “A Derivational Approach to the Interpretation of Scrambling Chains,” *Lingua* 113: 481-518.
- Saito, Mamoru (2004) “Ellipsis and Pronominal Reference in Japanese Clefts,” *Nanzan Linguistics* 1: 21-50.
- Saito, Mamoru (2007) “Notes on East Asian Argument Ellipsis,” *Language Research* 43: 203-227.
- Saito, Mamoru (2014a) “Case and Labeling in a Language without ϕ -feature Agreement,” in Anna Cardinaletti, Guglielmo Cinque and Yoshio Endo, eds., *On Peripheries: Exploring Clause Initial and Clause Final Positions*, 269-297, Hituzi Syobo Publishing, Tokyo.
- Saito, Mamoru (2014b) “Selection and Incorporation in Complex Predicate Formation,” in Audrey Li, Andrew Simpson and Wei-Tien Dylan Tsai, eds., *Chinese Syntax in a Cross-Linguistic Perspective*, 251-269, Oxford University Press, New York.
- Saito, Mamoru (2015) “Ellipsis,” to appear in Shigeru Miyagawa and Masayoshi Shibatani, eds., *Handbook of Japanese Syntax*, Walter de Gruyter, Berlin.
- Saito, Mamoru and Keiko Murasugi (1990) “N'-deletion in Japanese: A Preliminary Study,” *Japanese/Korean Linguistics* 1: 285-301.
- Sato, Yosuke (2015) “Argument Ellipsis in Javanese and Voice Agreement,” *Studia Linguistica* 69: 58-85.
- Sells, Peter (1995) “Korean and Japanese Morphology from a Lexical Perspective,” *Linguistic Inquiry* 26: 277-325.
- Şener, Serkan (2010) *(Non-)Peripheral Matters in Turkish Syntax*, Ph.D. dissertation, University of Connecticut.
- Şener, Serkan and Daiko Takahashi (2010) “Argument Ellipsis in Japanese and Turkish,” *MIT Working Papers in Linguistics* 61: 325-339.
- Shinohara, Michie (2004) “On the Ellipsis Phenomena in Japanese,” B.A. thesis, Nanzan University. (in Japanese)
- Shinohara, Michie (2006) “An Investigation into Argument Ellipsis in Japanese,” M.A. thesis, Nanzan University. (in Japanese)
- Simpson, Andrew, Arunima Choudhury and Mythili Menon (2013) “Argument Ellipsis and the Licensing of Covert Nominals in Bangla, Hindi and Malayalam,” *Lingua* 134: 103-128.

- Tada, Hiroaki (1993) *A/A-bar Partition in Derivation*, Ph.D. dissertation, MIT.
- Takahashi, Daiko (2008) "Quantificational Null Objects and Argument Ellipsis," *Linguistic Inquiry* 39: 307-326.
- Takahashi, Daiko (2013) "Argument Ellipsis in Japanese and Malayalam," *Nanzan Linguistics* 9: 173-192.
- Takahashi, Daiko (2014) "Argument Ellipsis, Anti-agreement, and Scrambling," in Mamoru Saito, ed., *Japanese Syntax in Comparative Perspective*, 88-116, Oxford University Press, New York.
- Takahashi, Masahiko (2010) "Case, Phases, and Nominative/Accusative Conversion in Japanese," *Journal of East Asian Linguistics* 19: 319-355.
- Takahashi, Masahiko (2011) *Some Theoretical Consequences of Case-marking in Japanese*, Ph.D. dissertation, University of Connecticut.
- Ura, Hiroyuki (1999) "Checking Theory and Dative Subject Constructions in Japanese and Korean," *Journal of East Asian Linguistics* 8: 223-254.
- Watanabe, Akira (2010) "Notes on Nominal Ellipsis and the Nature of *no* and Classifiers in Japanese," *Journal of East Asian Linguistics* 19: 61-74.
- Webelhuth, Gert (1989) *Syntactic Saturation Phenomena and the Modern Germanic Languages*. Ph.D. dissertation, University of Massachusetts, Amherst.
- Yang, Dong-Whee (1983) "The Extended Binding Theory of Anaphors," *Language Research* 19: 169-192.
- Yumoto, Yoko (1997) "Word Formation and the Lexical-Conceptual Structure," in Publishing Committee, ed., *Aspects of Language and Culture*, 105-118, Eihoosha, Tokyo. (in Japanese)